

Fan Performance Characteristics of Centrifugal Fans

Introduction

There are two general classifications of fans: the propeller or axial flow fan (see FE-2300) and the centrifugal or radial flow fan. In the broadest sense, what sets them apart is how the air passes through the impeller.

The propeller or axial flow fan propels the air in an axial direction (Figure 1a) with a swirling tangential motion created by the rotating impeller blades.

In a centrifugal fan the air enters the impeller axially and is accelerated by the blades and discharged radially (Figure 1b). The one exception to this is the tangential/transverse fan where the air enters and discharges radially through the impeller.

The axial flow fan increases the air velocity through rotational or tangential force which produces velocity pressure (VP), kinetic energy, with a very small increase in static pressure (SP), potential energy.

The centrifugal fan induces airflow by the centrifugal force generated in a rotating column of air producing potential energy (SP) and also by the rotational (tangential) velocity imparted to the air as it leaves the tip of the blades producing kinetic energy (VP).

Figure 2 illustrates the components that make up a typical centrifugal fan and covers the common terminology of these components.

Figure 1a. Axial Flow

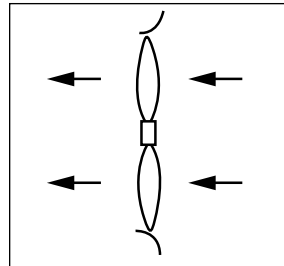

Figure 1b. Centrifugal Flow

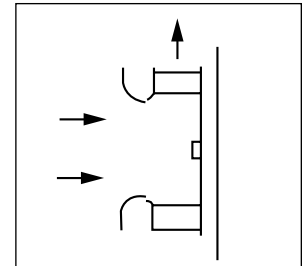
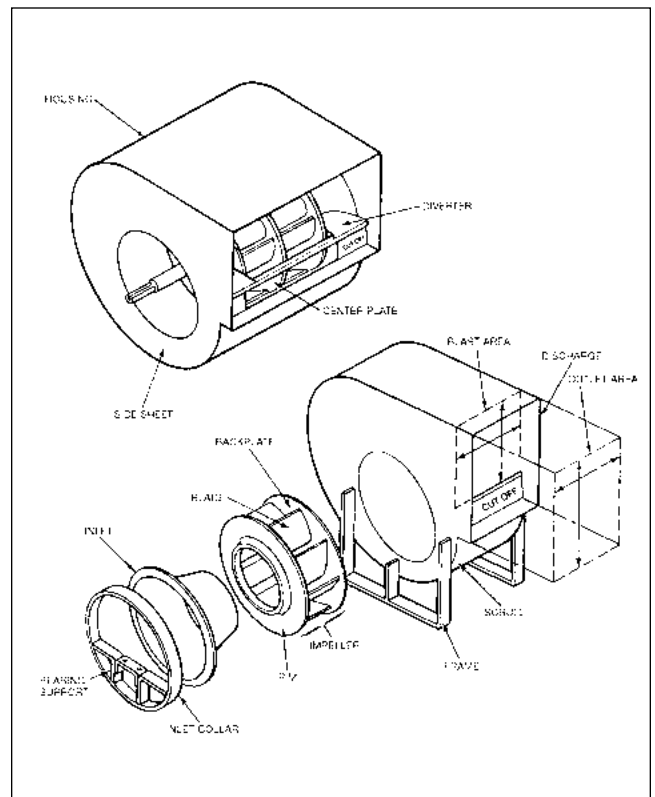

Figure 2. Terminology for Centrifugal Fan Components



Wheel Types

Centrifugal fans may be classified into three basic types according to blade configuration:

1. Forward curve
2. Backward inclined
3. Radial or straight blade

Each type has its own application range and limits. Modifications of these basic types include radial tip, mixed flow, and tangential flow.

The tip speed required to produce the required air particle velocity varies substantially with the type of blade used. Figures 3a, 3b, and 3c (Figure 3) show vector diagrams of forces in forward curve, backward curve, and radial blade impellers, respectively. Vector V_1 represents the rotational or tangential velocity, and V_2 represents the radial velocity of the airflow between the blades with respect to the various blade shapes.

Figure 3. Wheel Vector Diagrams

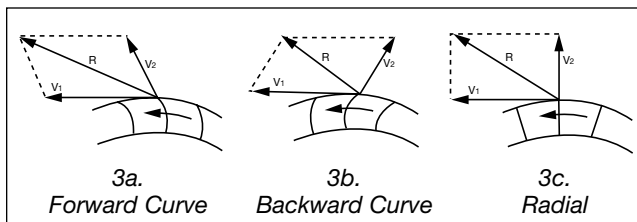

Vector R represents the resultant velocity for each of these blade shapes. Note that R for the forward curve impeller is the largest with the backward inclined impeller the smallest, while the radial blade fan lies somewhere in between. This relationship is best illustrated in Figure 4, which shows a typical tip speed/static pressure relationship for various types of centrifugal fans.

Figure 4. Tip Speed/Static Pressure Relationship

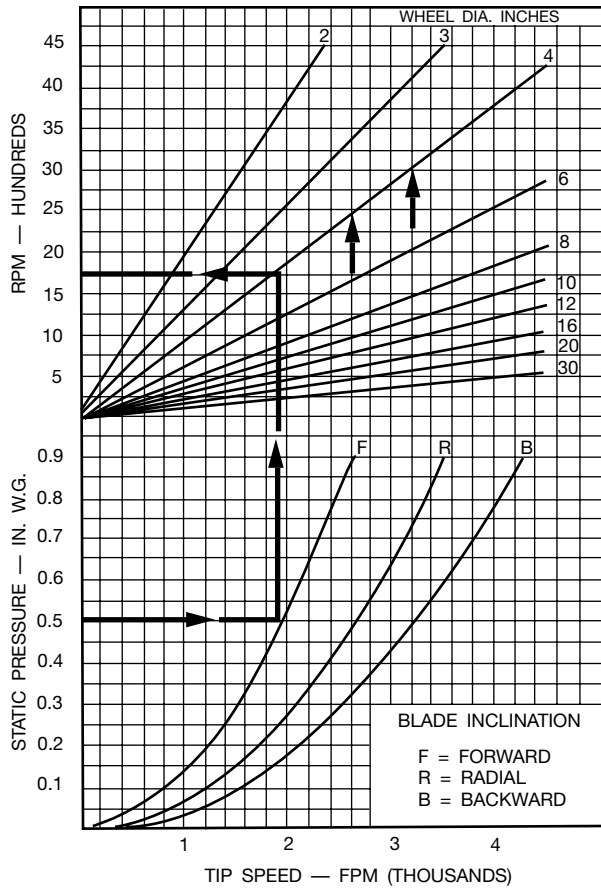

Forward Curve Fans

These fans are sometimes known as “volume,” “squirrel cage,” or “sirocco” blowers. The impeller blades are small and numerous with a pronounced curvature and short chord length. The concave blade curvature faces the direction of rotation. These fans operate at relatively low speeds and pressures (reference Figure 4) which permits light construction of the impeller, shaft, bearings, and housing.

Figure 5a. Typical Forward Curve Fan

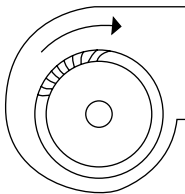
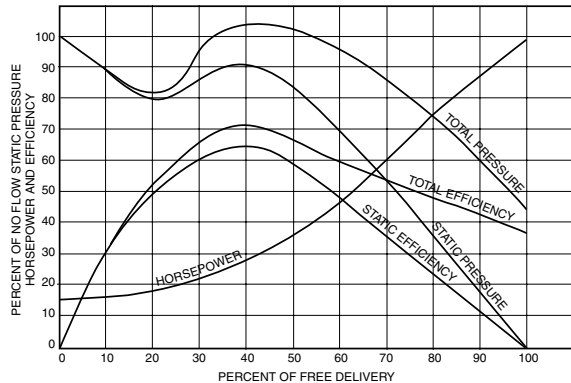

Figure 5b. Characteristic Performance of Forward Curve Fans



The forward curve fan is used to deliver high air volumes against static pressures up to 6" water gauge. However, the majority of applications are for pressures of 3" water gauge or less. Note the pronounced dip (stall) in the static pressure curve (Figure 5b). Any selection to the left of the 40% free delivery point (peak) will result in an unstable pulsating airflow that will lead to impeller and structural damage. Even though good peak efficiencies are on either side of the peak, selections should be limited to 45% or greater of free delivery.

Interestingly, in parallel installations, if selected too close to peak, forward curve fans exhibit a tendency not to share the load equally and become unstable. These selections should be limited to 55% or greater of free delivery.

The advantage of the forward curve fan is its low speed and quiet operation. The light construction results in a low cost fan and its relatively high airflow results in a small fan requiring minimum space, making it ideal for the residential and commercial heating and cooling market.

Disadvantages are that its high horsepower requirements at or near free delivery (note the rising power curve in Figure 5b) and its light construction limit its suitability for most industrial requirements.

Highly dependent on the housing for performance, the forward curve impeller is not suitable for plug or plenum fan applications. Without a housing the forward curve impeller becomes unstable and exhibits a relatively poor performance.

Backward Inclined Fans

These are sometimes called “load limiting” or “non-overloading” fans. The impeller blades are larger and heavier than forward curve blades, usually number from eight to twelve, and are inclined away from the direction of rotation. They are standardly offered in three blade shapes:

1. Flat single thickness (Figure 6a)
2. Curved single thickness (Figure 6b)
3. Curved airfoil (Figure 6c)

Figure 6. Backward Inclined Fans

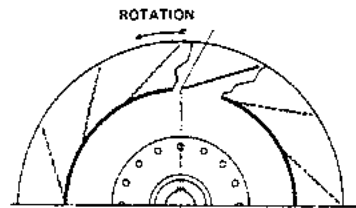

6a. Flat Single Thickness, BI

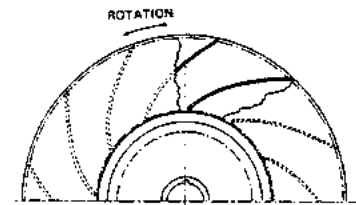

6b. Curved Single Thickness, BC

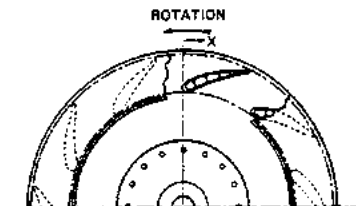

6c. Curved Airfoil, BIA

Backward inclined fans are used to deliver medium to high airflow at static pressures up to 20" water gauge. Pressures up to 40" water gauge are attainable with special construction.

The normal selection range for quiet, efficient performance is from 40% to 85% of free delivery (Figure 7). While these fans do not exhibit a deep stall range like the forward curve fan, there is a range of instability left of peak. The single thickness blades are more sensitive to the breakaway airflow in this area than the airfoil and should be selected to the right of peak.

Figure 7 shows the characteristic of a flat blade design; however, it typifies the characteristics of the entire family of backward inclined blade shapes. Only subtle differences exist between their static pressure curves.

Figure 7. Characteristic Performance of Backward Inclined Flat Blade Fans

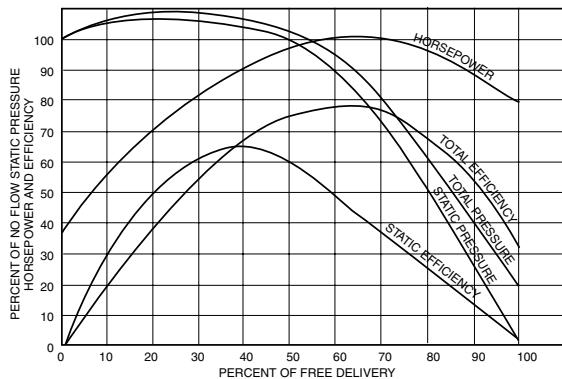

An attractive feature of the backward inclined types is the non-overloading characteristic of their horsepower curves. As Figure 7 illustrates, the horsepower increases to a maximum as airflow increases, and then drops off again toward free delivery. This means that a motor selected to accommodate the peak horsepower will not overload, despite variations in the system resistance or airflow, as long as the fan speed remains constant.

Typically the flat bladed design has efficiencies of about 82%, while the curved blade and airfoil designs approach 86% and 90%, respectively.

The backward inclined "family" of fans has the highest operating speeds of all the centrifugal fans (Figure 4). While this is a desirable feature for direct connection to modern "high speed" motor or turbine drives, it comes with a price. Their high operating speed requires heavier construction and precision balancing, making them fairly expensive compared to forward curve fans. Also, the close running clearances required to maintain fan performance makes them unsuitable for material handling. However, in single thickness blade construction they can be used in light dust and corrosive air.

These fans are used primarily in the industrial market for ventilation, clean side of commercial air cleaning devices, furnace draft and large commercial heating and cooling units. The air leaving the backward inclined impeller has less of its total energy in the form of velocity pressure than does the air leaving a forward curve impeller. Because more of its energy is in the form of static pressure, a backward inclined impeller loses less energy in the process of converting from velocity pressure to static pressure in the housing. Therefore, a backward inclined impeller can operate quite satisfactorily without a housing, making it suitable for specialty fans such as plug fans, plenum fans, and in-line centrifugal fans, whose characteristics are all similar to Figure 7, just slightly less efficient.

Radial Blade Fans

"Steel plate" or "paddle wheel" are two of the common names for radial blade fans. The impeller blades are generally narrower, deeper and heavier than forward curve and backward inclined blades. A radial blade impeller usually comprises six to twelve equally spaced flat blades extending radially from the center of the hub. These impellers are generally of simple design that lends itself to rugged construction and offers a minimum of ledges, etc., for the accumulation of dust or sticky materials.

There are more variations of the radial blade fans than the forward curve and backward inclined types. Three of the more common impellers are illustrated in Figure 8.

Figure 8. Common Radial Blade Impellers

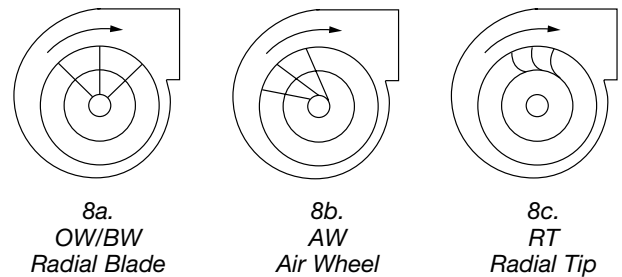

The open wheel (OW), paddle wheel; and the back-plate wheel (BW), steel plate, are the most common of the radial blade impellers, and their typical performance characteristics are shown in Figure 9. These fans are generally selected to operate from 35% to 80% of free delivery. However, it should be noted that these fans can, and do, operate quite successfully left of peak, down to approximately 20% of free delivery.

Figure 9. Characteristic Performance of Radial Blade Fans

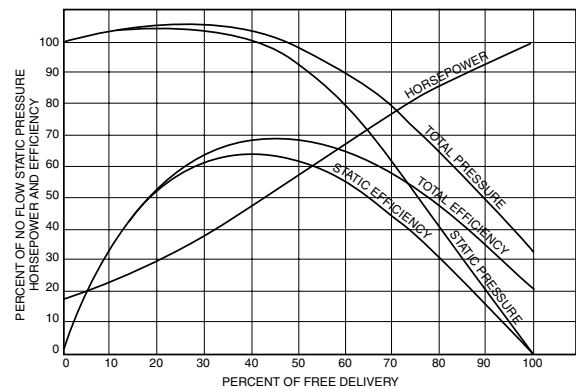

From Figure 4 it can be seen that these are medium speed fans and are used to deliver low air volumes at medium to high pressure. The main advantage of the radial blade fan lies in its simple but rugged construction. They are ideal for high static pressure applications and for handling airstreams containing a high level of particulate.

Some of the disadvantages are that they generate more noise than forward curve and backward inclined fans, primarily because of the impeller design and high operating velocities and they exhibit the same rising horsepower characteristic as the forward curve fans. Because they are low volume fans, larger sizes are generally required, taking up a larger installation space. Fan efficiencies are lower than both the forward curve and backward inclined type, but this is generally offset by their ability to adapt to harsh environments.

For higher efficiencies most manufacturers offer some variation of the air wheel (AW) impeller, Figure 8b, to operate in the same housing as the straight radial blade impellers. For even higher efficiencies and airflow, manufacturers also offer a radial tip (RT) impeller; however, in most cases the radial tip impeller operates in a housing similar to the backward inclined design. The radial tip design fills the gap between the clean air backward inclined fans and the more rugged radial blade fans.

Both the air wheel and the radial tip impellers are ideal for contaminated airstreams but neither is intended for bulk material handling. Both impellers have pressure characteristics similar to the backward inclined impellers

and a horsepower characteristic similar to the radial blade and forward curve impellers. Unlike the straight radial blade impellers these two impeller designs do exhibit some instability left of peak and should always be selected to the right of peak.

By and large, the radial blade series of fans are used exclusively in the industrial market for handling and conveying various process materials and gases. They are used for "high pressure" air systems and for combustion air. Generally speaking, they are furnished in belt drive arrangements due to the high shock loads and harsh environments to which they are exposed.



AEROVENT | WWW.AEROVENT.COM

5959 Trenton Lane N | Minneapolis, MN 55442 | Phone: 763-551-7500 | Fax: 763-551-7501