

Single-Phase AC Induction Squirrel Cage Motors

Introduction

It is with the electric motor where a method of converting electrical energy into mechanical energy to perform some physical task or work is possible. The electric motor is by far the most common method for powering a ventilating fan today. There are many classifications of motor types available, but this paper will focus on single-phase AC induction squirrel cage motors which is where the largest number of motors are utilized in ventilation.

On the following pages the basic operation and types of AC single-phase induction motor types will be covered. This paper will focus on the electrical arrangement inside the motor housing, discuss the principles governing motor design, and help the user understand what can and cannot be done with the motor in terms of power and electrical control.

Figure 1 is a listing of the basic motor classifications.

Index

- Introduction – Motor Classifications1
- Basic Principles2
- AC Motor Fundamentals2
- Motor Stator2
- Motor Rotor3
- Magnetic Field for Single-Phase Motors3
- Motor Starting for Single-Phase Motors.3
- Motor Speed-Torque Curves4
- Motor Efficiency4
- Split-Phase Motors5
- Capacitor-Start Motors6
- Permanently Split Capacitor Motors7
- Capacitor Start-Capacitor Run Motors.8
- Shaded Pole Motors9
- Summary10

Figure 1. Electric Motor Classifications by Electrical Type

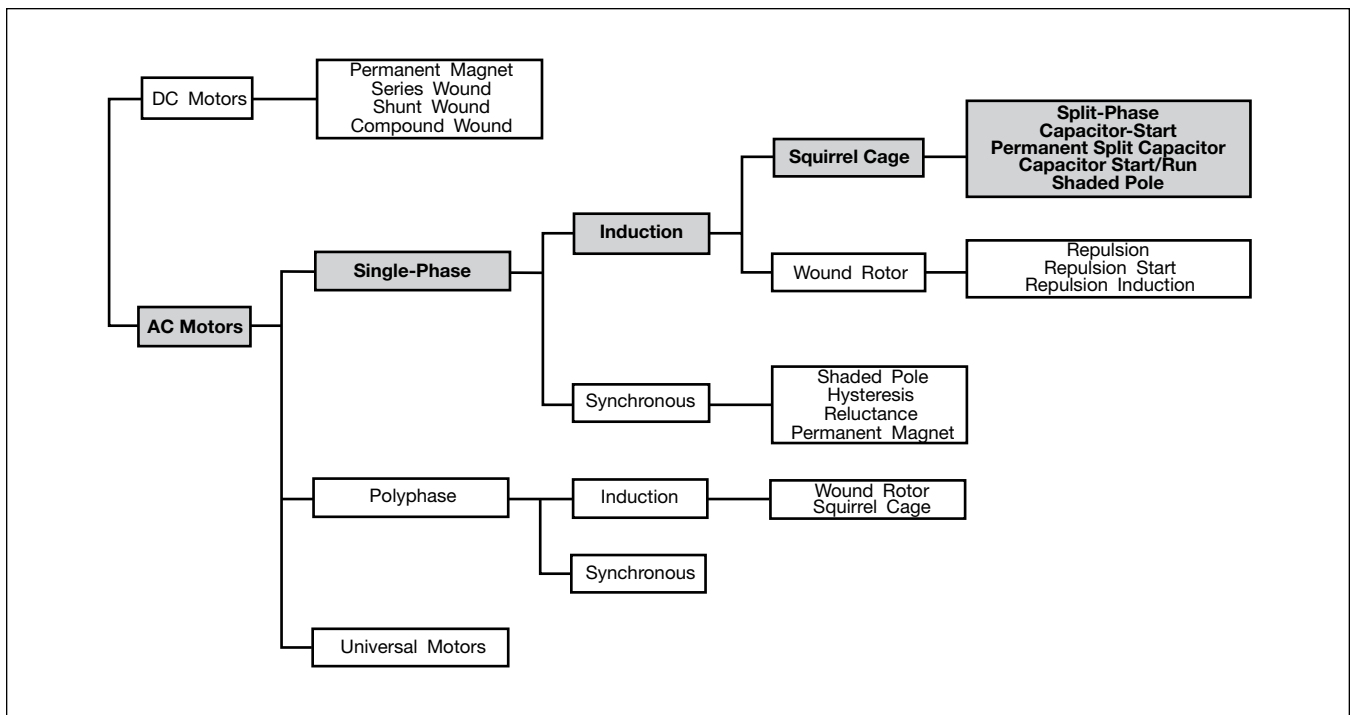

AC Induction Motor Fundamentals

Basic Principles

In order to understand how the single-phase AC induction motor works a basic understanding of the physical principles and fundamentals governing motor design and operation is required. We will start with the basic principle on which the induction motor is able to convert electrical energy into mechanical energy.

The basic operation of an AC induction motor is based on two electromagnetic principles:

1. Current flow in a conductor will create a magnetic field surrounding the conductor, and,
2. If a conductor is moved through this magnetic field, current is induced in the conductor and it will create its own magnetic field.

The fundamental single-phase AC induction motor consists of two basic parts (see Figure 2).

Figure 2. Basic Components of a Single-Phase AC Induction Motor

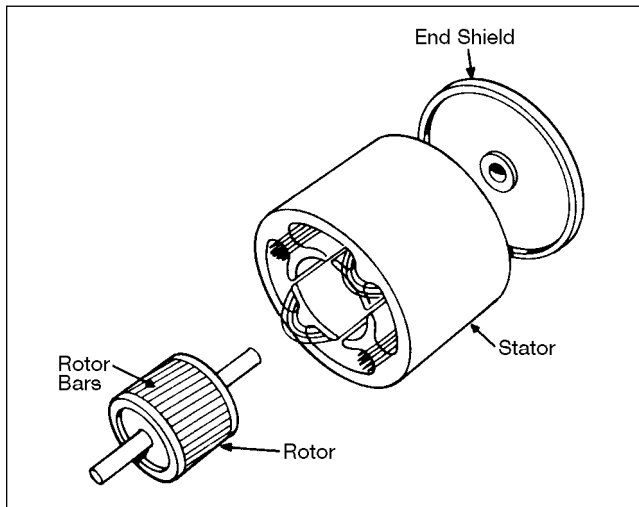

1. **Stator.** The stator is constructed of a set of stacked laminated discs which are surrounded by a stator winding. This winding is connected to the proper power supply (voltage, phase and frequency) and produces a magnetic field that revolves around the motor at a speed designated "synchronous."
2. **Rotor.** The rotor is connected to the output shaft and consists of a shorted aluminum winding which is cast into slots and stacked and joined at both ends of the stack with end rings. The rotor acts as a conductor which when placed in the magnetic field of the stator winding creates a magnetic field of its own and interacts with the magnetic field of the stator, producing torque.

The first principle applies to the magnetic field created by the stator and the second applies to the rotor as it rotates within the stator field.

Before we cover the characteristics of the various motor types, it may be useful to review in detail the basic electromagnetic principles which enable the induction motor to convert electrical energy into a mechanical output through the motor shaft. We will start by taking a look into the two main components (stator and rotor) of single-phase AC motors. In the following section we will discuss their construction and the fundamental principles of their operation.

Stator

Whenever current flows in a conductor, a magnetic field is built up around it (Figure 3). If the conductor is formed into a coil, the magnetic field created is similar to that of a permanent bar magnet (Figure 4). If a bar of magnetic material such as iron or steel is placed within the coil, the magnetic field is strengthened because these materials transmit magnetic flux much more readily than air.

Figure 3. Magnetic Field Surrounding Conductor

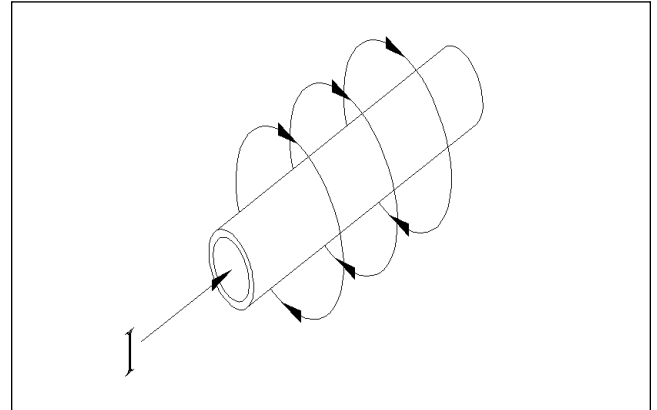

Figure 4. Magnetic Field Produced by a Simple Coil with Permanent Magnet

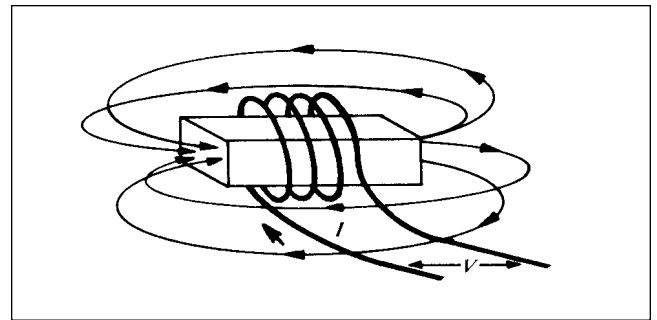
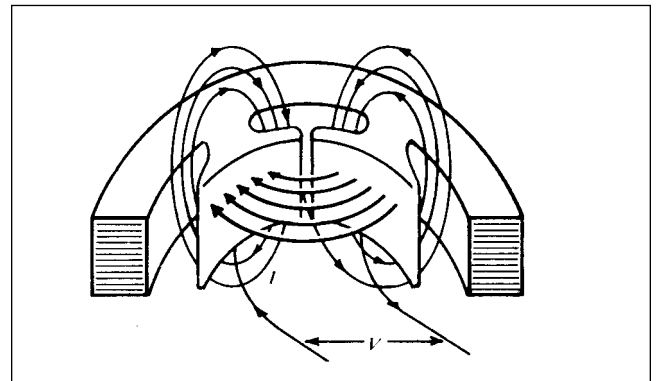

Figure 5 is a view of one half of a four pole stator. The placement of the coils resembles the relative positioning of the coil and bar of Figure 4 and the resulting magnetic fields are also similar. By reversing the direction in which one coil is wound in the stator relative to the adjacent coil, the direction of current flow is reversed, as illustrated in Figure 5. This reversal in the direction of current flow also changes the magnetic polarity, creating adjoining north and south poles in the stator.

Figure 5. Flux Patterns Produced in Stator



In the completed stator, a magnetic field is created having alternating north and south poles. The number of magnetic poles in the stator, together with the AC line frequency, determines the speed at which the motor will operate.

Rotor

If a conductor is moved between the faces of a horseshoe magnet (Figure 6), a voltage is induced in that conductor, and if the conductor forms part of a completed circuit, current will flow. The action which produces this voltage and current is the cutting of the magnetic field (called lines of magnetic flux) by the conductor. This current flow within the conductor will in turn produce a magnetic field, as seen in Figures 3 and 6. The interaction of these two magnetic fields produces a mechanical force on the wire which is the basis for the production of torque.

Figure 6. Elements of Motor Action

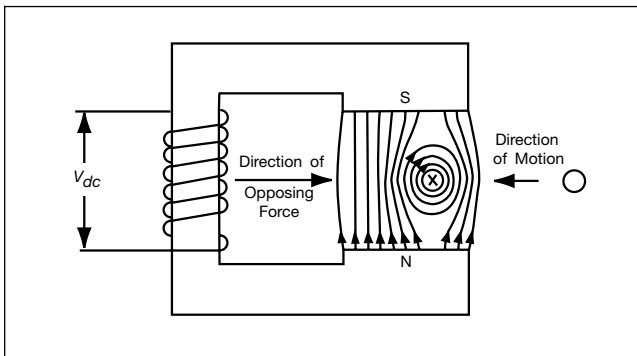

In an induction motor, the single conductor of the previous example is replaced by the rotor winding. In small motors, this winding is normally of cast aluminum and consists of multiple conductors, or rotor bars, cast into the slots in the rotor core and joined at both ends of the stack with end rings. The resulting rotor winding circuit is illustrated in Figure 7, and as can be seen from this figure, the name has been designated as "squirrel cage rotors."

Figure 7. Representation of Voltage-Current Paths (and Strengths) in Squirrel Cage Rotor

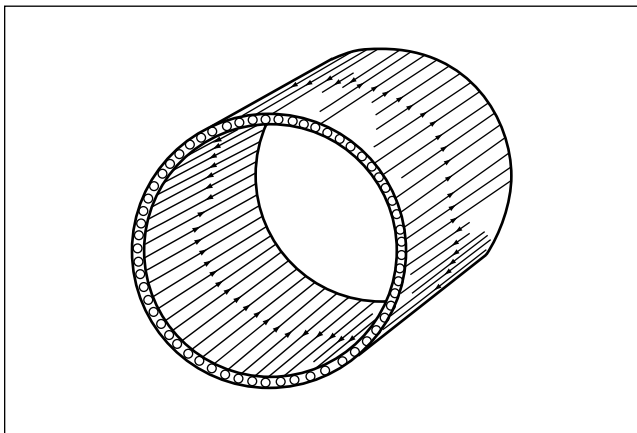

As a rotor turns, the rotor bars cut through the flux lines of the stator magnetic field and voltages and currents are induced in each bar. The magnitude of the voltage and current in a given bar will depend on the magnetic density of the stator field which the rotor bar

is passing through at that time. Because the strength of the stator field varies around its circumference, being strongest at each pole, the voltages and currents induced in the rotor bars will also vary around the rotor. Figure 7 illustrates the directions and magnitudes of a typical rotor bar current pattern. The magnetic field built up around each bar reacts with the stator flux, exerting a force on each bar in the same manner as previously described in the example of the horseshoe magnet and simple conductor. The sum total of all forces acting on all rotor bars is the output torque of the motor.

Magnetic Field for Single-Phase Motors

In order for the rotor to move, the stator must produce a rotating magnetic field. With a single source of AC voltage connected to a single winding, this is not possible. A stationary flux field is created which pulsates in strength as the AC voltage varies, but it does not rotate. This pulsating field strength is what simulates a rotating field and gives the rotor its rotation. If a stationary rotor is placed in this single-phase stator field, it will not rotate, but if the rotor is spun by hand, it will pick up speed and run. The single-phase motor will run (in either direction) if started by hand, but it will not develop any starting torque as illustrated in Figure 8.

Motor Starting for Single-Phase Motors

What is needed is a second (start) winding, with currents out of phase with the original (main) winding, to produce a net rotating magnetic field. The various single-phase motor designs differ in the type of secondary (start) winding employed. These start windings, which together with other components such as capacitors, relays and centrifugal switches, make up the starting circuit, provide varying effects on motor starting and running characteristics.

Figure 8. Speed-Torque Characteristics of Single-Phase, Single Main Winding Only Motor

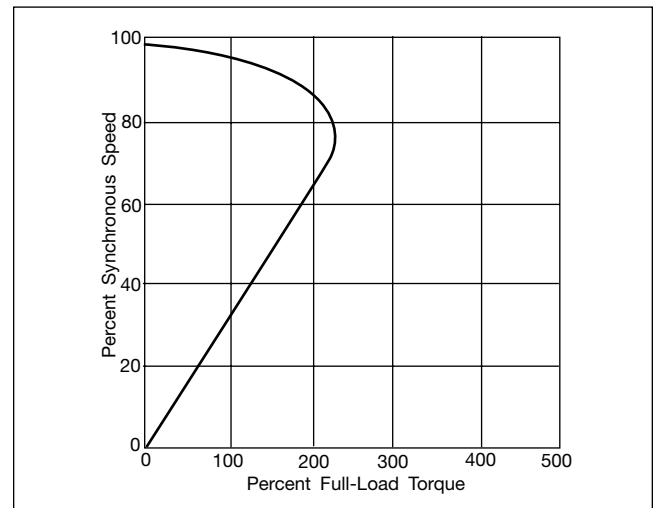

Two basic mathematical models best reveal two important facts about single-phase motors:

1. The performance characteristics of single-phase motors can approach, but will not exceed that of the two-phase polyphase motors.
2. The torque produced at a given RPM is not constant, but pulsates at twice the line frequency around a median value. These torque pulsations are inherent to

all single-phase motors and can cause noise and vibration problems if not properly isolated.

Motor Speed-Torque Curves

Determining what motor is necessary for the application is done through examining motor speed-torque curves. There is much information on a speed-torque curve to tell the end user if the motor will operate satisfactorily for the intended application. The speed-torque curve will allow the user to determine if the motor has enough starting torque to overcome friction, to accelerate the load to full running speed, and if it can handle the maximum overload expected. See Figure 9 for a typical speed-torque curve.

Figure 9. Typical Motor Speed-Torque Curve

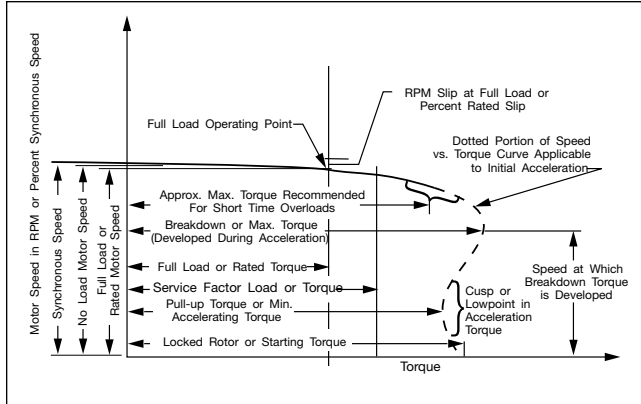

There are many torques that can be obtained from a motor's speed-torque curve:

- **Locked Rotor (Starting) Torque** — Motor torque at zero speed.
- **Pull-Up Torque** — Lowest torque value between zero and full load speed.
- **Breakdown Torque** — Maximum torque without motor stalling.
- **Full Load Torque** — Torque produced by motor at full load operating point.

As we further describe the five types of single-phase AC induction motors, reference to the speed-torque curves will be crucial to understanding each motor type and its operating characteristics.

Motor Efficiency

Single-phase AC induction squirrel cage peak motor efficiencies range from as low as 30% to as high as 65%, depending on the motor type and design. Motor efficiencies also depend on the actual motor load versus rated load. Refer to Figure 10.

The best motor for the job is often suggested by the nature of the load. Motor efficiency usually is greatest at the full load rating and falls off rapidly for under and overloaded conditions as can be seen in Figure 10.

The misconception that a motor running well below its maximum load rating will run cooler and more efficiently is not true. Oversizing AC motors reduces efficiency by a substantial amount, causing a larger part of the input energy to be dissipated as heat. On the other end of the scale, overloading of motors is a much better understood concept as many other signs indicate a poor motor selection (reduced speed, high ampere draw, tripped motor overloads). The amount of electrical power

wasted can be reduced by a more careful application of a motor to the actual load. It is typically best to run an AC single-phase squirrel cage motor at no less than 75% full load and no greater than 125% full load from an efficiency standpoint. Again, motor efficiency is greatest near its full load rating.

Figure 10. Motor Efficiency vs. Motor Load

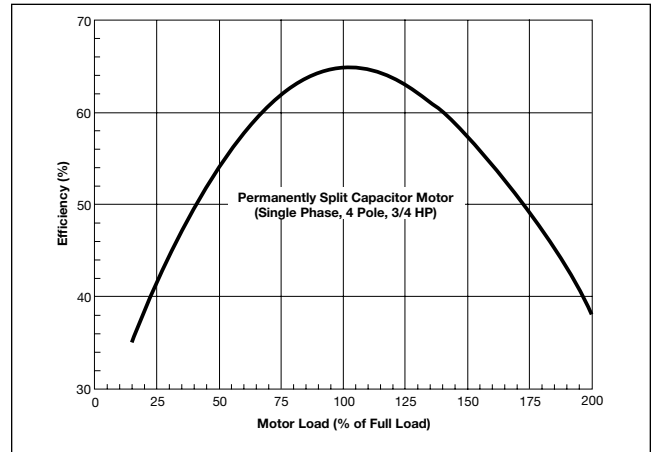

Another design criteria affecting motor efficiency is operating voltage. Motors are generally designed to operate at a given rated voltage, with a plus and minus tolerance (10% is typical). Within the tolerance level, efficiency generally increases for higher voltages, but decreases for lower voltages. The decrease is due to greater I²R losses (because of the substantial length of wire required in the winding, this results in I²R losses because of the principle that the wire resistance increases with its length). Low operating voltage also reduces torque, which decreases as the square of the voltage. Refer to Figure 11.

Figure 11. Effect of Voltage on Motor Efficiency

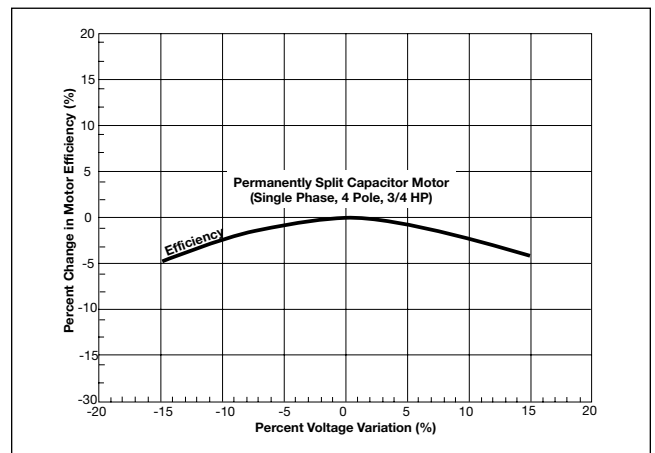

Beyond these considerations, the motor design determines its efficiency. There are several ways to reduce power losses in the motor. One is to reduce losses in the core, either by adding more material to the magnetic core structure or by using a steel with improved core-loss properties. Another method is to increase the cross-sectional area of conductors to reduce resistance. This means that additional winding material must be added to the stator and rotor. Another alternative is to shorten the air gap between the rotor and stator to reduce the magnetizing current required. A final method

Split-Phase Motors (SP)

used is to simply add more material to the magnetic core which will reduce the amount of current required to magnetize the core.

Figure 12 illustrates schematically the winding arrangement of a typical distributed winding arrangement of a split-phase motor. A split-phase motor's components are a main winding, start winding and a centrifugal switch.

Figure 12. Winding Schematic for SP Motor

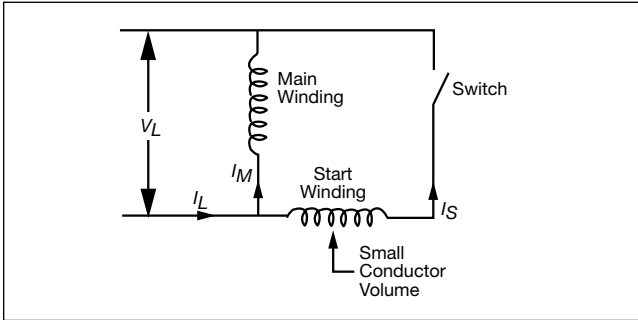

The main (run) winding is designed for operation from 75% synchronous speed and above. The main winding design is such that the current lags behind the line voltage because the coils embedded in the steel stator naturally build up a strong magnetic field which slows the buildup of current in the winding. This relationship between the line voltage and line current is shown in Figure 13.

The start winding is not wound identically to the main, but contains fewer turns of much smaller diameter wire than that of the main winding coils. This is required to reduce the amount the start current lags the voltage. This can also be seen in Figure 13.

When both windings are connected in parallel across the line, the main and start winding currents will be out of time phase by about 30 degrees. This forms a sort of imitation of a weak rotating flux field which is sufficient to provide a moderate amount of torque at standstill and start the motor.

Figure 13. Phase Relationships (SP Motor)

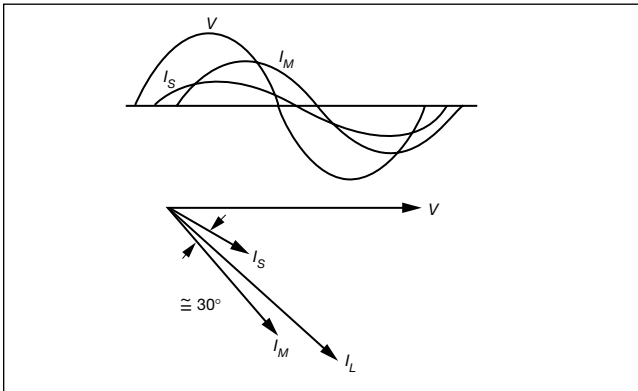

The total current that this motor draws while starting is the vector sum of the main and start winding currents. Because of the small angle between these two, the line current during starting (inrush current) of split-phase motors is quite high. Also the small diameter wire in the start winding carries a high current density, so that it heats up very rapidly. A centrifugal switch mechanism (or relay) must be provided to disconnect the start winding from the circuit once the motor has reached an adequate speed to allow running on the main winding only. Figure 14 illustrates the speed-torque relationship of a typical split phase motor on both the running and starting connection. Table 1 summarizes the split-phase motor characteristics.

Figure 14. General Performance Characteristic (SP Motor)

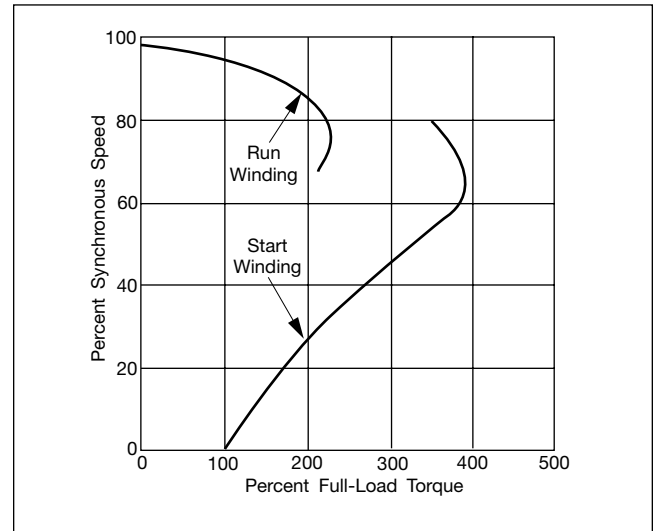

CHARACTERISTIC	NOTES
Peak Efficiency	50 to 60%
Power Factor	60 to 70%
Starting Torque	100% Full Load Torque
Noise & Vibration	120 Hz Torque Pulsations
Components	Contains Centrifugal Switch
Other	High Inrush Starting Current
Cost	Moderate

Capacitor-Start Motors (CSIR)

Table 1. Summary of Split-Phase Motor Characteristics

Figure 15 illustrates schematically the winding arrangement of a typical distributed winding arrangement of a capacitor-start motor. It should be noted that the capacitor-start motor utilizes the same winding arrangement as the split-phase motor, but adds a capacitor in series with the start winding. The effect of this capacitor is shown in Figure 16. The main (run) winding current remains the same as in the split-phase case, but the start winding current is very much different. With the capacitor in the circuit, the starting current now leads the line voltage, rather than lagging as does the main winding. The start winding is also different, containing slightly more turns in its coils than the main winding and utilizing wire diameters only slightly smaller than those of the main.

Figure 15. Winding Schematic for CSIR Motor

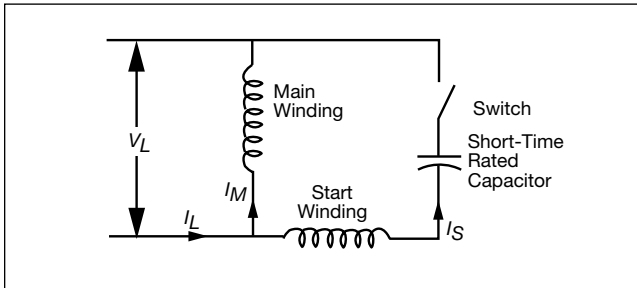
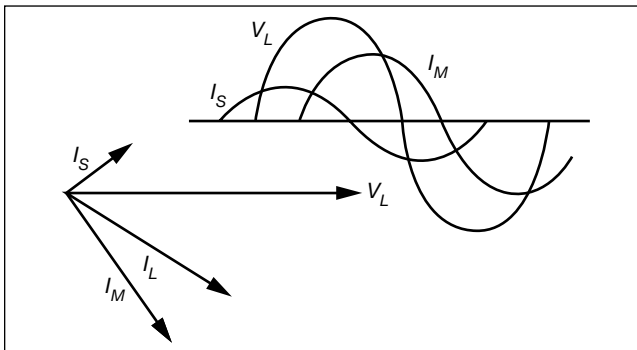

Figure 16. Phase Relationships (CSIR Motor)



The new result is a time phase shift closer to 90 degrees than with the split-phase motor. A stronger rotating field is therefore created and starting torque is higher than with the split-phase design. Also the vector sum of the main and start winding currents is lower, resulting in a reduction in the inrush current as compared to the split-phase design. Refer to Figure 16.

The starting and running speed-torque characteristic of a capacitor-start motor is illustrated in Figure 17. Again, a centrifugal switch and mechanism (or relay) must be used to protect the start winding and capacitor from overheating. When the capacitor-start motor is running near full load RPM, its performance is identical to that of the split-phase motor. Table 2 summarizes the capacitor-start motor characteristics.

Figure 17. General Performance Characteristic (CSIR Motor)

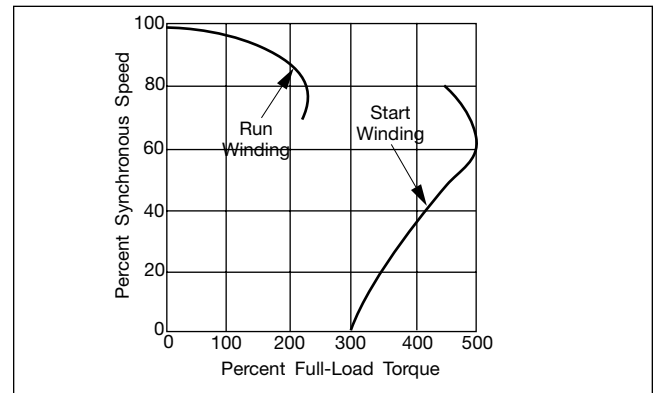

Table 2. Summary of Capacitor-Start Motor Characteristics

CHARACTERISTIC	NOTES
Peak Efficiency	50 to 60%
Power Factor	60 to 70%
Starting Torque	Up to 300% Full Load Torque
Noise & Vibration	120 Hz Torque Pulsations
Components	Contains Centrifugal Switch & Capacitor (Intermittent Duty)
Other	Capacitor Controls Inrush Starting Current (Lower Than Split-Phase Type)
Cost	Slightly Higher Than Split-Phase Type

Permanently Split Capacitor Motors (PSC)

Figure 18 illustrates schematically the winding arrangement of a typical distributed winding arrangement of a permanently split capacitor motor. The windings of the PSC motor are arranged like those of the split-phase and capacitor-start designs, but a capacitor capable of running continuously replaces the intermittent duty capacitor of the capacitor-start motor and the centrifugal switch of both the split-phase and capacitor-start motors. The main winding remains similar to the previous designs, current lags the line voltage (refer to Figure 19).

Figure 18. Winding Schematic for PSC Motor

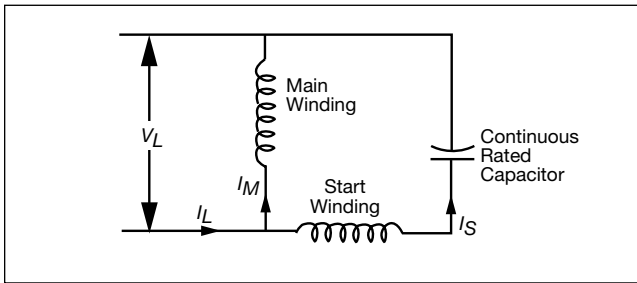

The start winding of a PSC motor is somewhat different than in the capacitor-start design. Because the capacitor for a PSC motor usually has a small rating, it is necessary to boost the capacitor voltage by adding considerably more turns to its coils than are in the main winding coils. Start winding wire size remains somewhat smaller than that of the main winding. The smaller microfarad rating of the capacitor produces more of a leading phase shift and less total start winding current, so starting torques will be considerably lower than with the capacitor-start design. Refer again to Figure 19.

Figure 19. Phase Relationships (PSC Motor)

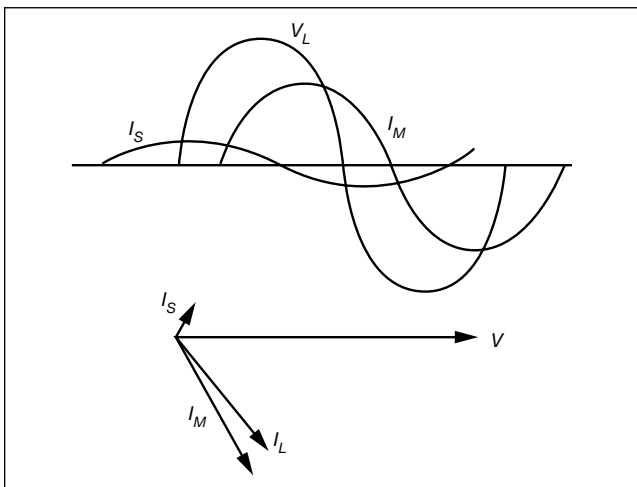

However, the real strength of the permanently split capacitor design is derived from the fact that the start winding and capacitor remain in the circuit at all times and produce an approximation of two-phase operation at the rated load point. This results in better efficiency, better power factor, and lower 120 Hz torque pulsations than in equivalent capacitor-start and split-phase designs.

Figure 20 illustrates a typical speed torque curve for a permanently split capacitor motor. Different starting and running characteristics can be achieved by varying the rotor resistance. In addition, by adding extra main windings in series with the original main windings, PSC motors can be designed to operate at different speeds depending on the number of extra main windings energized. It should also be noted that for a given full load torque, less breakdown torque and therefore a smaller motor is required with a permanently split capacitor design than with the other previously discussed designs. Table 3 summarizes the characteristics of the permanently split capacitor design.

Figure 20. General Performance Characteristic (PSC Motor)

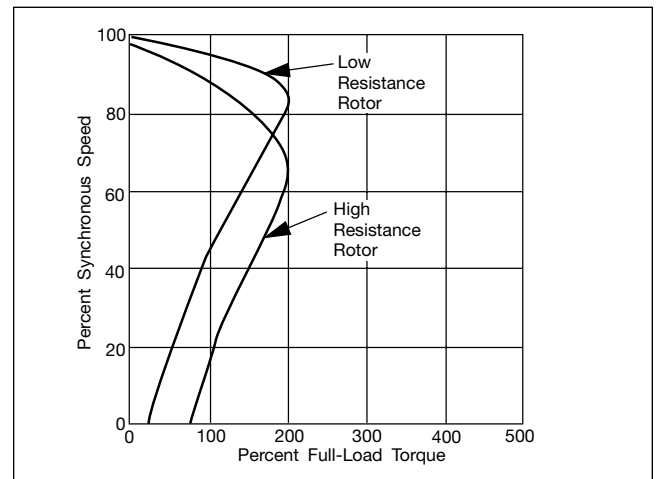

Table 3. Summary Permanently Split Capacitor Motor Characteristics

CHARACTERISTIC	NOTES
Peak Efficiency	55 to 65%
Power Factor	80 to 100%
Starting Torque	50 to 80% Full Load Torque
Noise & Vibration	120 Hz Torque Pulsations Reduced
Components	Contains Capacitor (Continuous Duty)
Other	Can be used with speed control devices (not possible with SP & CSIR types)
Cost	Smallest motor for given output

Capacitor Start-Capacitor Run Motors (CSCR)

Figure 21 illustrates schematically the winding arrangement of a typical distributed winding arrangement of a capacitor start-capacitor run motor. These motors have a run capacitor and an auxiliary winding permanently connected in parallel with the main winding. In addition, a starting capacitor and a centrifugal switch are also in parallel with the run capacitor. The switch disconnects as the motor accelerates. It should be noted that the capacitor start-capacitor run motor utilizes the same winding arrangement as the permanently split capacitor motor when running a full load speed and the same winding arrangement as a capacitor-start motor during startup.

Figure 21. Winding Schematic for CSCR Motor

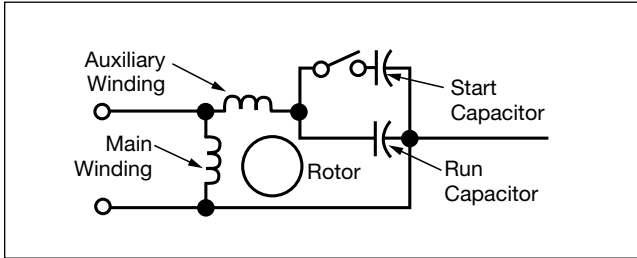

The advantage of the capacitor start-capacitor run design is derived from the fact that the start winding and capacitor remain in the circuit at all times (similar to PSC type motor) and produce an approximation of two-phase operation at the rated load point, plus with an additional capacitor in series with the start winding circuit (similar to the capacitor-start type motor), the starting current now leads the line voltage, rather than lagging as does the main winding, dramatically increasing starting torque. Capacitor start-capacitor run motors feature a low running current due to an improved power factor caused by the run capacitor.

This results in better efficiency, better power factor, increased starting torque and lower 120 Hz torque pulsations than in equivalent capacitor-start and split-phase designs. The capacitor start-capacitor run motor is basically a combination of the capacitor-start and PSC motor types and is the best of the single-phase motors.

Figure 22 illustrates a typical speed torque curve for a capacitor start-capacitor run motor. With the advantage of combining both the PSC and capacitor-start designs these motors have been extended up to ratings as high as 20 HP, far beyond what the other single-phase motor types are capable.

Table 4 summarizes the characteristics of the capacitor start-capacitor run motor.

Figure 22. General Performance Characteristic (CSCR Motor)

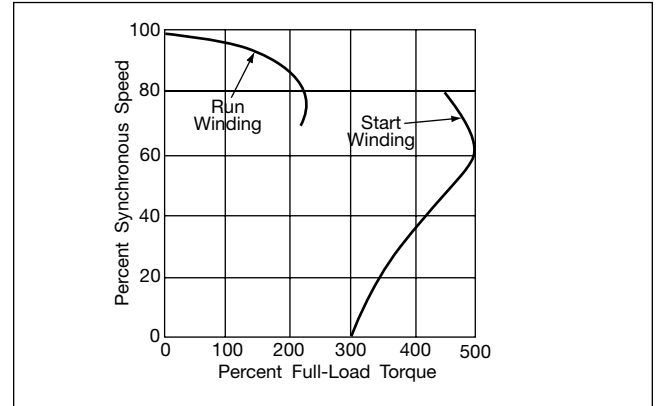

Table 4. Summary Capacitor Start-Capacitor Run Motor Characteristics

CHARACTERISTIC	NOTES
Peak Efficiency	55 to 65%
Power Factor	80 to 100%
Starting Torque	Up to 300% Full Load Torque
Noise & Vibration	120 Hz Torque Pulsations Reduced
Components	Contains Centrifugal Switch & Capacitor (Intermittent Duty). Contains 2nd Capacitor (Continuous Duty).
Other	Capacitor controls inrush starting current & run capacitor simulates 2-phase operation.
Cost	The best of the single-phase motor types. Exceptionally quiet. Most expensive motor design type.

Shaded Pole Motors

The shaded pole motor differs widely from the other single-phase motors which have been discussed. All of the other designs contain a main and start winding, differing only in details of the starting method and corresponding starting circuitry.

The shaded pole motor is the most simply constructed and therefore the least expensive of the single-phase designs. It consists of a run winding only plus shading coils which take the place of the conventional start winding. Figure 23 illustrates the construction of a typical shaded pole motor. The stator is of salient pole construction, having one large coil per pole wound directly in a single large slot. The shading coils are short circuited copper straps which are wrapped around one pole tip of each pole.

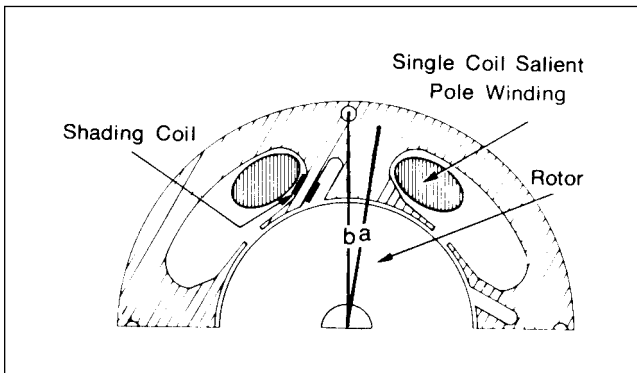

Figure 23. Shaded Pole Motor Construction

The shaded pole motor produces a very crude approximation of a rotating stator field through magnetic coupling which occurs between the shading coils and the stator winding. The placement and resistance of the shading coil is chosen so that, as the stator magnetic field increases from zero at the beginning of the AC cycle to some positive value, current is induced in the shading coil. As previously noted, this current will create its own magnetic field which opposes the original field. The net effect is that the shaded portion of the pole is weakened and the magnetic center of the entire pole is located at point "a". As the flux magnitude becomes nearly constant across the entire pole tip at the top of the positive half cycle, the effect of the shading pole is negligible and the magnetic center of the pole shifts to

point "b". As slight as this shift is, it is sufficient to generate torque and start the motor.

The single coil winding is the crudest possible approximation of a rotating magnetic field. Therefore, the shaded pole motor efficiency suffers greatly due to the presence of winding harmonic content, particularly the third harmonic which produces a dip in the speed torque curve at approximately 1/3 synchronous speed (refer to Figure 24). In addition there are losses in the shading coils. These factors combine to make the shaded pole the least efficient and noisiest of the single-phase designs. It is used mostly in air moving applications where its low starting torque and the third harmonic dip can be tolerated. Extra main windings can be added to provide additional speeds in a manner similar to that used on permanently split capacitor motors. Table 5 summarizes the characteristics of a shaded pole motor.

Figure 24. General Performance Characteristic (Shaded Pole Motor)

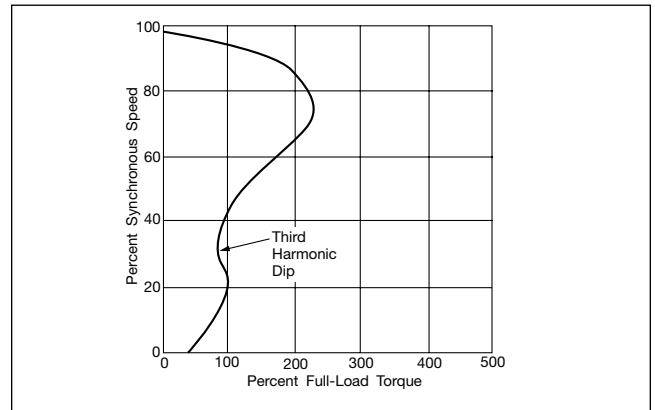

Table 5. Summary Shaded Pole Motor Characteristics

CHARACTERISTIC	NOTES
Peak Efficiency	20 to 40%
Power Factor	50 to 60%
Starting Torque	40 to 50% full load torque plus third harmonic dip
Noise & Vibration	120 Hz torque pulsations plus winding harmonics
Components	No additional components needed
Other	Can be used with speed control devices (not possible with SP & CSIR types)
Cost	Cheapest of all single-phase motors

Summary

Single-phase AC motors are not all equal. There are five basic types, all with different operating characteristics and capabilities. As it has been shown, the differences between each motor type are great enough that it is important for the user to understand each motor type, where it makes sense to apply them and how to apply them.

What does knowing the previous technical information on these five types of motors have to do with fans? The answer is simply this: almost every commercial fan is powered by an electric motor and other than the fan wheel it is by far the most important component of a fan. The motor is the most likely component to fail in a fan and a large percentage of fan motor failures can be attributed to poor selection and application of the motor.

Speed control capability is also becoming more commonplace today (especially on direct drive fans) and applying today's speed controllers to any single-phase AC motor can prove disastrous. It is important to understand that there are only two types of single-phase AC squirrel cage motor types that are suited for speed control applications.

Understanding the starting characteristics of each motor type is another area of importance for the motor application to a particular fan. All five motor types have distinct starting characteristics that need to be properly matched with the fan starting characteristics.

The table below can be used as a quick reference to the five motor types along with typical (acceptable) fan applications for each motor type.

Table 6. Summary of Five Single-Phase Motor Types

MOTOR TYPE	SPLIT-PHASE	CAPACITOR-START	PERMANENTLY SPLIT CAPACITOR	CAPACITOR START-CAPACITOR RUN	SHADED POLE
DESCRIPTION	Start winding connected in parallel with main winding, connection controlled by centrifugal switch or relay.	Identical to the split-phase design except includes the addition of a capacitor in series with the start winding circuit.	Start winding permanently connected in parallel to main winding with a continuous duty capacitor in the circuit at all times.	Combination of capacitor-start and PSC type motor. Start winding permanently connected in parallel to main winding with a continuous duty capacitor in the circuit at all times and capacitor in series with the start winding circuit.	Single main winding with shading coils for providing starting torque.
HP RANGE	1/6 to 1	1/4 to 2	1/100 to 1	3/4 to 20	1/1000 to 1/4
TYPICAL RATED	860, 1140, 1725, 3450	860, 1140, 1725, 3450	1050, 1625, 3250	1725, 3450	1050, 1550, 3100
EFFICIENCY RANGE	50 to 60%	50 to 60%	55 to 65%	55 to 65%	20 to 40%
POWER FACTOR	60 to 70%	60 to 70%	80 to 100%	80 to 100%	50 to 60%
STARTING TORQUE	100%	Up to 300%	50 to 80%	Up to 300%	40 to 50%
TYPICAL	Suitable for frequent starting of fans in both direct and belt driven units.	All-purpose motor for high starting torque, low starting current used in both direct and belt driven units.	Intended for direct drive models and applications requiring speed control.	All-purpose motor for high starting torque, low starting current used mainly in larger belt driven units.	Suitable for direct drive low power fans and multi-speed applications.
ADVANTAGES	a. Good starting torque. b. Medium efficiency.	a. High starting torque. b. Lower starting current than split phase design.	a. High running efficiency. b. Capable of multi-speed operation. c. Can be used with speed control devices (i.e., triacs). d. Quietest of all small induction motors.	a. High starting torque. b. Lower starting current than split-phase design. c. Available in larger HP sizes than capacitor-start or PSC motor types. d. High running efficiency.	a. Inexpensive to manufacture. b. Multi-speed operation. c. Compact.
DISADVANTAGES	a. Not suited for high starting torque loads. b. Not applicable for speed control. c. High starting current	a. More expensive than split-phase design. b. Not applicable for speed control.	a. Low starting torque. b. Speed varies more under load.	a. Most expensive single-phase motor type. b. Not applicable for speed control.	a. Low efficiency. b. Low starting torque.



AEROVENT | WWW.AEROVENT.COM

5959 Trenton Lane N | Minneapolis, MN 55442 | Phone: 763-551-7500 | Fax: 763-551-7501